

VR2650: 2xVR41, VR2652, VR2629
 VR2651: 2xVR41, VR2652, VR2629 (USA)
 VR2654: 4xVR2647, VR2648, 2xVR2650, 2xVR266A

Additional parts
Zusätzliche Teile
Supplerede dele
Ytterligere delar

Remote control
 Fernbedienung
 Fjernbetjening
 Fjärrkontroll

Afstandsbediening
 Contrôle à distance
 Telemando
 2625 

Power supply
 Netzteil
 Strømforsyning
 Strömförsörjning

Stroomvoorziening
 Alimentation
 Convertidor adaptador 

2622: ROW&GB
 2626: EU

EU	GB	US	AUS
● ●	■ ■		/ \
Type: C	G	A	I

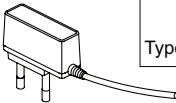
 2623: IPX5

Extension
 2639 - 5 m
 2645 - 10 m

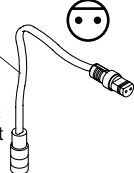
Black Svart
 Schwartz Zwart
 Sort Noir 

Signal cable
 Signalkabel

Signaalkabel
 Câble de signal
 Cable de señal 

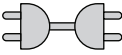
41XX, 49XX:
 509 - 1.5 m 
 509A - 5 m
 509B - 10 m

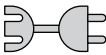
RB1E, HV1E:
 2656 - 1.5 m 

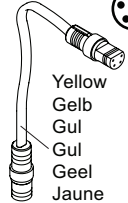
Yellow
 Gelb
 Gul
 Gul
 Geel
 Jaune 

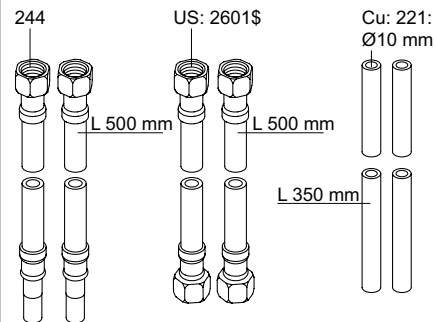

Adapter
 Adapteur

Discontinued model
 aufgeföhrte Modell
 Udgået model
 Avvecklad modell
 Beändigde model
 Modèle discontinué

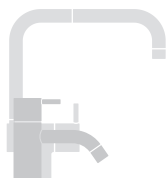
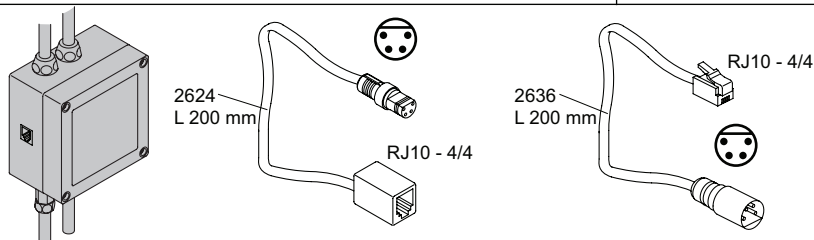

vola
 Lunavej 2
 DK-8700 Horsens
 Tlf : + 45 7023 5500
 sales@vola.com
 www.vola.com

VOLA VR2618
HV1E/4100/4900

Date:
 Oct. 18

Rev.:
 2

Sheet:
SB21.16