

--

Fecha:
Cliente:
Proyecto:



**2471-081**

Mezclador monomando con inversor y válvula cerámica.

2471-081UP = Mezclador 2400F.

2471-081AP = Mando NR21, mando NR24G, ducha de mano 070 con válvula de no retorno y soporte, cabezal de ducha 080 de 115 mm, arandela 001 de 60 mm, arandela 001G de 60 mm y arandela 2001 de 60 mm.

**Flujo**

	Bar:	1,0	2,0	3,0	4,0	5,0
070	(l/min)	5,2	7,3	9,0	9,0	9,0
080	(l/min)	6,9	9,8	12,0	13,9	15,5

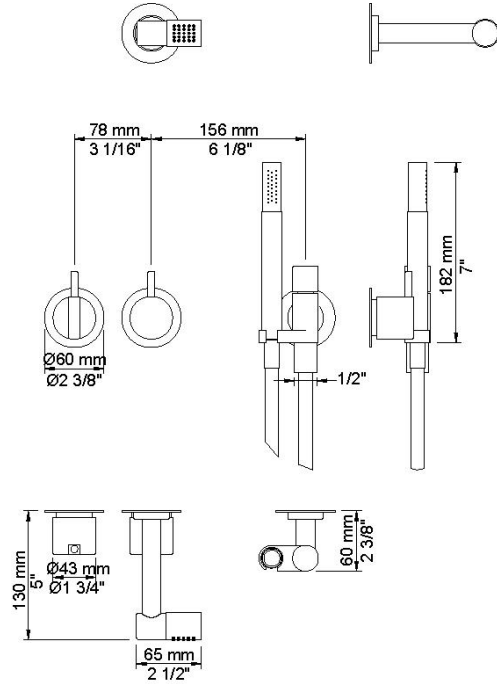

**Disponible en colores**

02 Gris	25 Rosa
04 Azul claro	27 Negro mate
05 Naranja	28 Blanco mate
06 Verde claro	60 Negro
08 Amarillo	61 Negro cepillado
09 Gris oscuro	62 Negro profundo
12 Mocca	63 Cobre
14 Rojo brillante	64 Cobre cepillado
15 Azul oscuro	65 Oro
17 Negro gloss	70 Oro cepillado
18 Blanco	Acero inoxidable cepillado
19 Latón natural	Color 68, Plata
20 Cromo cepillado	Cromo
21 Rojo carmin	

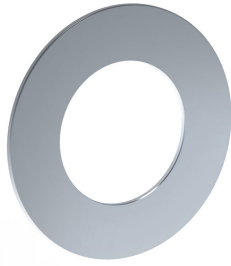

**001**  
Arandela de 60 mm.  
Orificio Ø30 mm.

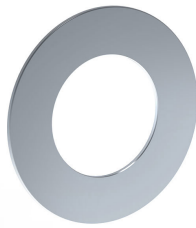
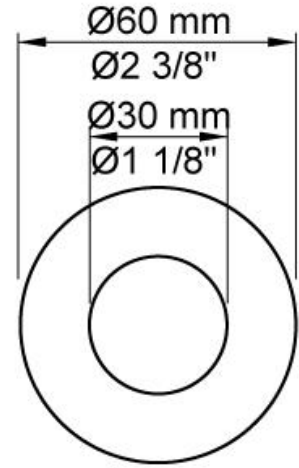

**001G**  
Arandela de 60 mm. Orificio Ø33 mm.

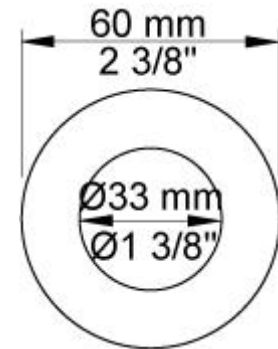

**070**  
Ducha de mano con válvula de no retorno y soporte.  
Flexo metálico.

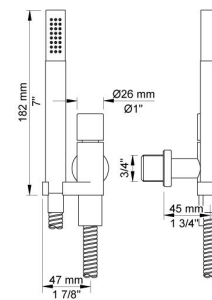



**080**  
Cabeza de ducha 130 mm.  
Incluido arandela de 60 mm.

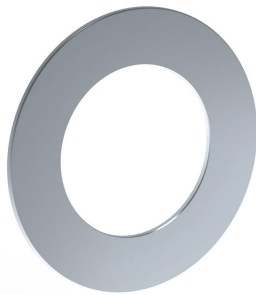
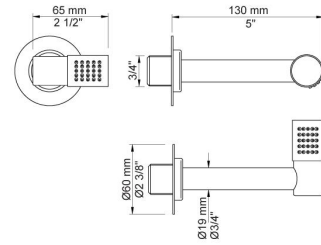

**2001**  
Arandela de 60 mm.  
Orificio Ø39 mm.

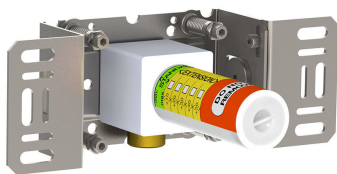
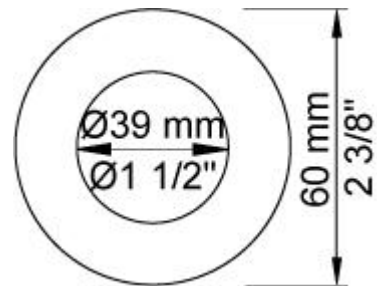

**200M**  
Salida separada.

